

UNBELIEVABLY POWERFUL.
INSANELY EASY.

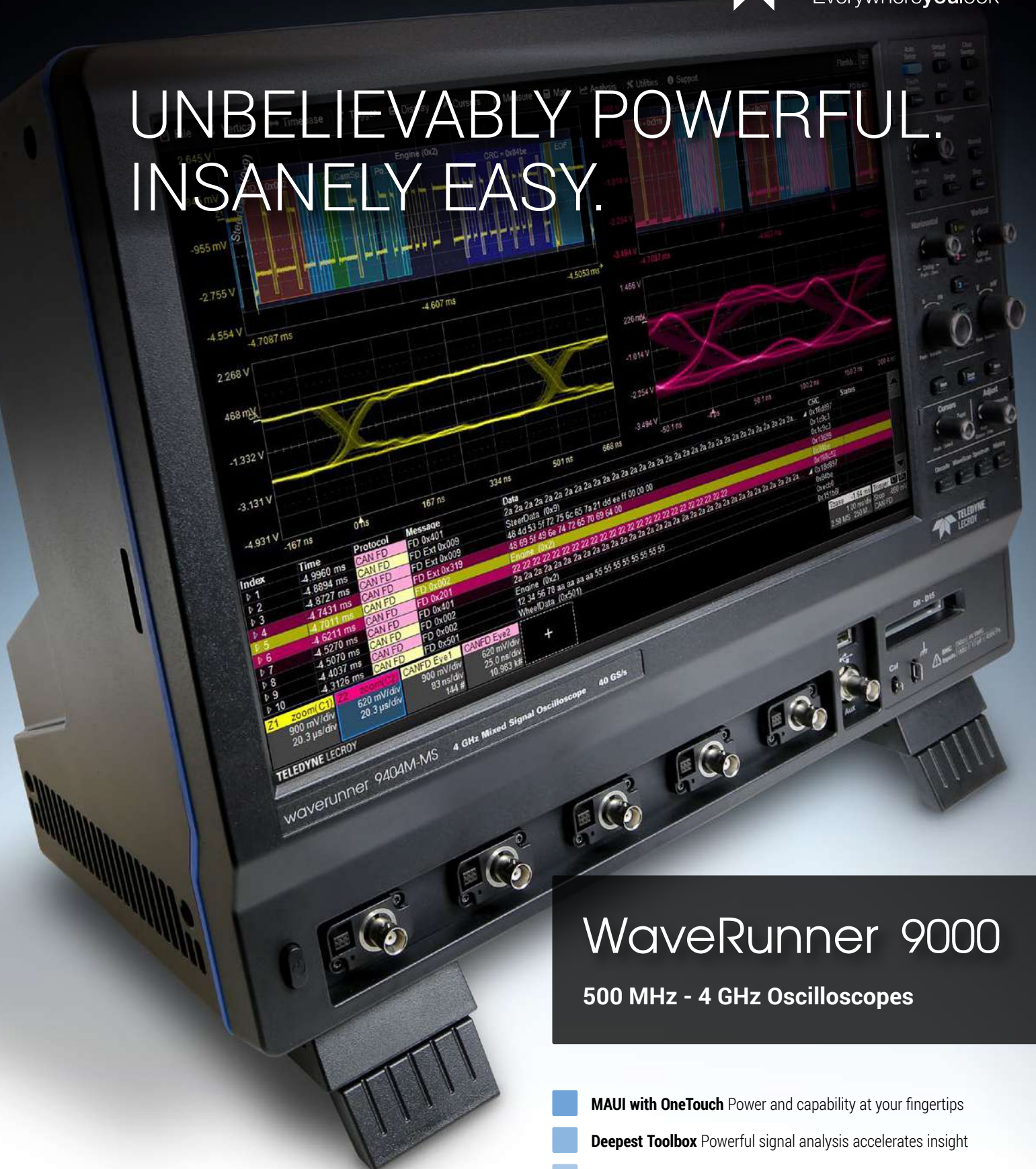

WaveRunner 9000

500 MHz - 4 GHz Oscilloscopes

- **MAUI with OneTouch** Power and capability at your fingertips
- **Deepest Toolbox** Powerful signal analysis accelerates insight
- **Exceptional Serial Data Tools** Most complete debug and validation

MAUI[®] with OneTouch

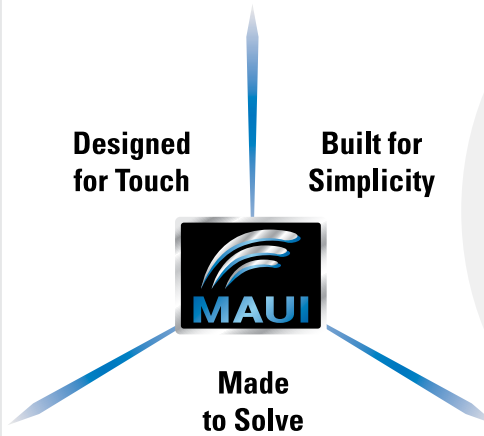

OneTouch delivers a superior user experience by providing gesture control of common operations.

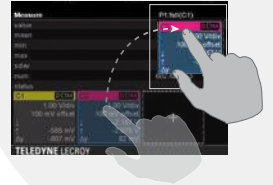

Deep Toolbox



WaveRunner 9000 has the greatest breadth and depth of tools to simplify any debug task.

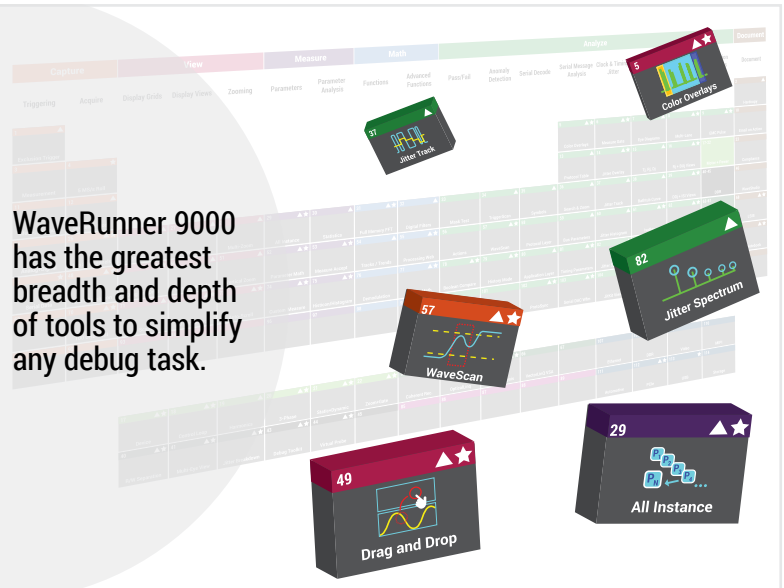

Serial Data Tools

WaveRunner 9000 features exceptional serial data debug and validation solutions

- Triggering
- Decoding
- Measurement and Graphing
- Eye Diagram and Physical Layer Analysis
- Jitter analysis and other advanced tools

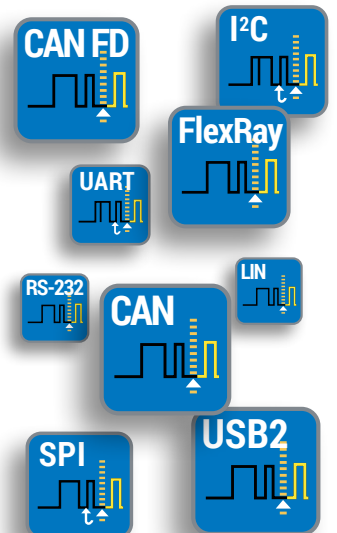



Faster Time to Insight

Insight alone is not enough.

Markets and technologies change too rapidly.

The **timing** of **critical design decisions** is significant.

Faster Time to Insight is what matters.



UNBELIEVABLY POWERFUL.
INSANELY EASY.



WaveRunner 9000

MAUI – SUPERIOR USER EXPERIENCE



- A** Channel, timebase, and trigger descriptors provide easy access to controls without navigating menus.
- B** Configure parameters by touching measurement results.

- C** Shortcuts to commonly used functions are displayed at the bottom of the channel, math and memory menus.
- D** Use the "Add New" button for one-touch trace creation.
- E** Drag to change source, copy setup, turn on new trace, or move waveform location.

- F** Drag to copy measurement parameters to streamline setup process.
- G** Drag to quickly position cursors on a trace.

Designed for touch

Operate the oscilloscope just like a phone or tablet with the most unique touch screen features on any oscilloscope. All important controls are always one touch away. Touch the waveform to position or zoom in for more details using intuitive actions.

Built for simplicity

Basic waveform viewing and measurement tools as well as advanced math and analysis capabilities are seamlessly integrated in a single user interface. Time saving shortcuts and intuitive dialogs simplify setup and shorten debug time.

Made to solve

A deep set of integrated debug and analysis tools help identify problems and find solutions quickly. Unsurpassed integration provides critical flexibility when debugging. Solve problems fast with powerful analysis tools.

POWERFUL, DEEP TOOLBOX

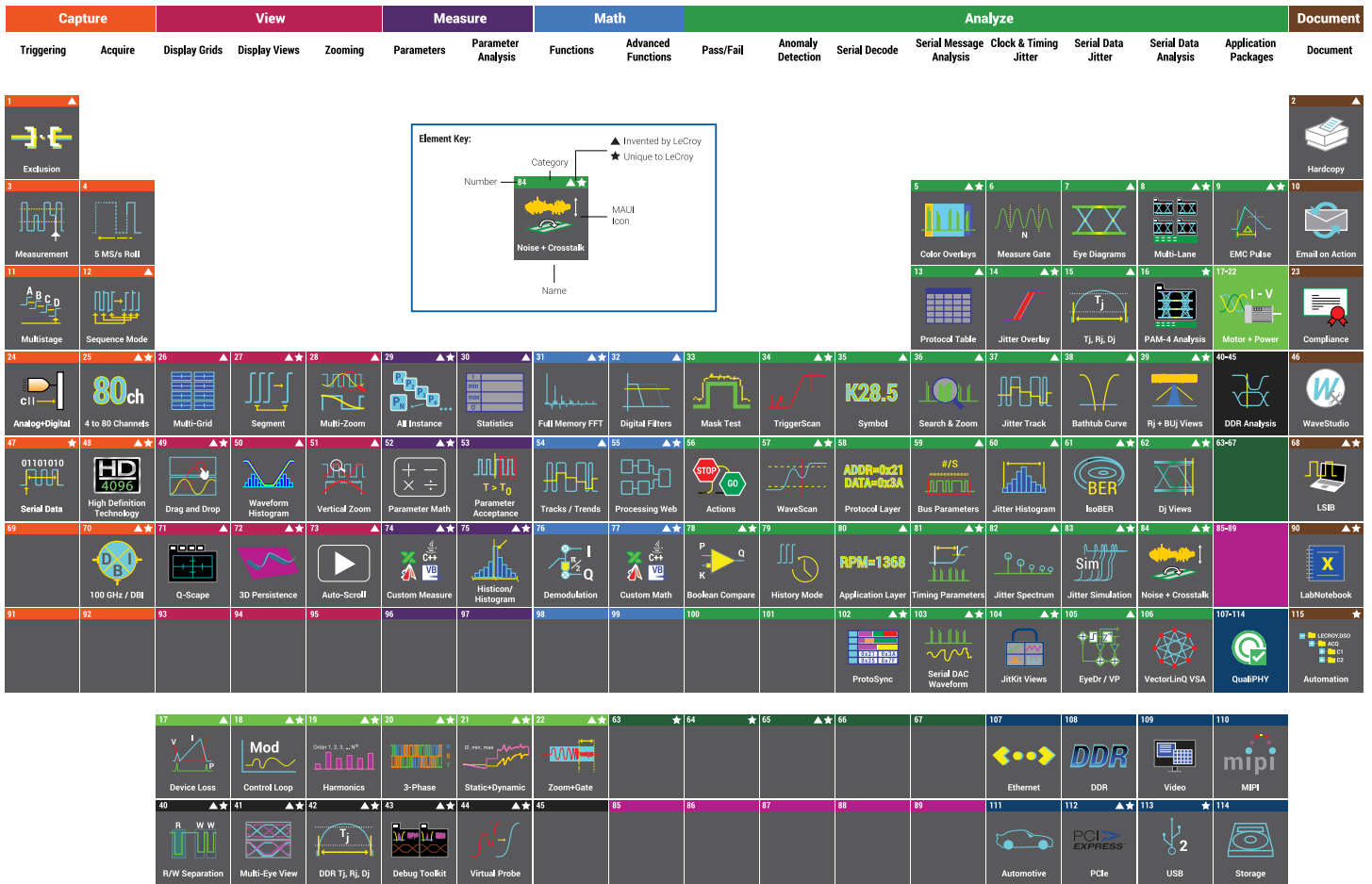

Our heritage

Teledyne LeCroy's 50+ year heritage is in processing long records to extract meaningful insight. We invented the digital oscilloscope and many of the additional waveshape analysis tools.

Our obsession

Our tools and operating philosophy are standardized across much of our product line. This deep toolbox inspires insight; and your moment of insight is our reward.

Our invitation

Our Periodic Table of Oscilloscope Tools explains the toolsets that Teledyne LeCroy has deployed in our oscilloscopes. Visit our interactive website to learn more about them.

teledynelecroy.com/tools

WaveRunner 9000

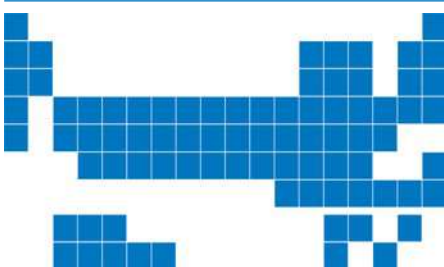

Competitor A



Competitor B

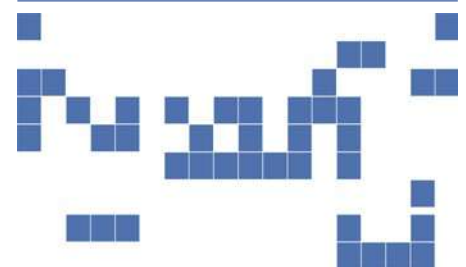

MOST COMPLETE SERIAL DATA DEBUG AND VALIDATION

The WaveRunner 9000 features the widest range and most complete serial data debug and validation solutions.

- Triggering
- Decoding
- Measurement and Graphing
- Eye Diagram and Physical Layer Analysis

Other advanced capabilities include

- Compliance Test
- Advanced jitter analysis tools
- Synchronization to protocol analyzer

Solutions address the following markets and applications:

- Embedded Computing
- Automotive
- Industrial
- Military and Avionics
- Peripherals
- Memory
- Handset/Mobile/Cellular
- High Speed Computing
- Data Storage
- Serial Digital Audio

T D

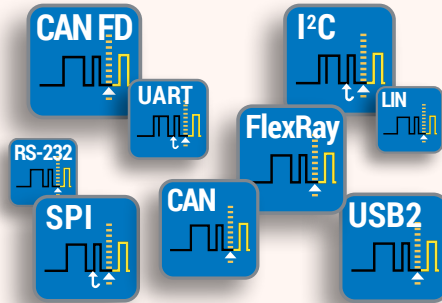

Trigger

Designed by people who know the standards, with the unique capabilities you want to isolate unusual events. Conditional data triggering permits maximum flexibility, and highly adaptable error frame triggering is available to isolate error conditions. Frame definition groups UART or SPI packets into message frames for customization. Sequence Mode ignores idle time and acquires only data of interest.

Decode

Decoded protocol information is color-coded to specific portions of the serial data waveform and transparently overlaid for an intuitive, easy-to-understand visual record. All decoded protocols are displayed in a single time-interleaved table. Touch a row in the interactive table to quickly zoom to a packet of interest and easily search through long records for specific protocol events using the built-in search feature.



ProtoSync

ProtoSync combines the oscilloscope view with a simultaneous view of data link layer decodes on the same instrument. This combination makes ProtoSync very effective in debugging protocol-specific negotiation rates.

Compatible with PCI Express, USB 2.0, USB2-HSIC, SAS, SATA, and Fibre Channel.

ME

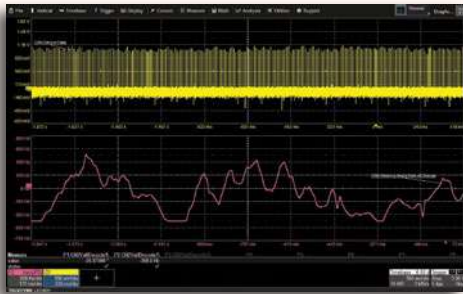

Measure/Graph

Quickly validate cause and effect with automated timing measurements to or from an analog signal or another serial message. Make multiple measurements in a single long acquisition to quickly acquire statistics during corner-case testing. Serial (digital) data can be extracted to an analog value and graphed to monitor system performance over time, as if it was probed directly. Complete validation faster and gain better insight.

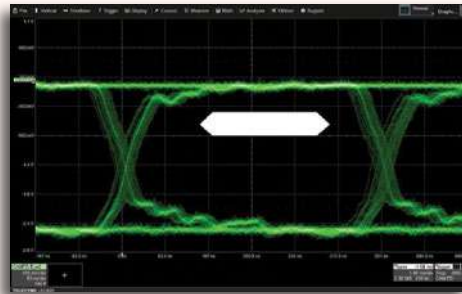

Eye Diagram

Rapidly display an eye diagram of your packetized low-speed serial data signal without additional setup time. Use eye parameters to quantify system performance and apply a standard or custom mask to identify anomalies. Mask failures can be indicated and can force the scope into Stop mode.

SDAIII or DDR Debug (optional) create eye diagrams of streaming NRZ serial data or DDR signals, and measure and analyze jitter breakdown.

QualiPHY / Compliance

Compliance testing is a critical part of the design cycle in order to ensure that requirements are met. The QualiPHY framework provides an automated and easy-to-use compliance testing platform for a number of serial data standards.



WaveRunner 9000 Serial Data Protocol Support

	Trigger	Decode	Measure/Graph	Eye Diagram	Protosync	QualiPHY	
Embedded Computing	I ² C	•	•	•	•	•	
	SPI	•	•	•	•	•	
	UART-RS232	•	•	•	•	•	
	USB2-HSIC		•				
Automotive + Industrial	CAN	•	•	•	•		
	CAN FD	•	•	•	•		
	FlexRay	•	•	•	•		
	LIN	•	•	•	•		
	SENT		•				
	MOST50/150					•	
	BroadR-Reach/ 100Base-T1					•	
1000Base-T1					•		
Avionics	ARINC429		•	•	•		
	MIL-STD-1553	•	•	•	•		
	SPACEWIRE		•				
	Ethernet (10/100Base-T)		•			•	
High Speed Computing, Storage + Peripherals	Ethernet (1000Base-T)					•	
	MDIO		•				
	USB 2.0	•	•	•	•	•	
	8b/10b	•	•	•	•		
	Fibre Channel		•				
	SATA (1.5 & 3 Gb/s)	•	•			•	
	SAS (1.5 & 3 Gb/s)		•			•	
	PCI Express (Gen1)		•			•	
	Memory	LPDDR2			•		•
		DDR2			•		•
DDR3				•		•	
MIPI	D-PHY/CSI-2/DSI	•	•	•	•		
	DigRF3G		•	•			
	DigRFv4		•	•			
	SPMI		•				
	UniPro		•				
	M-PHY	•	•	•	•		
	Audio (I ² S, LJ, RJ, TDM)	•	•	•	•		
Other	Manchester		•				
	NRZ	•	•	•	•		

EMBEDDED COMPUTING SYSTEMS TESTING

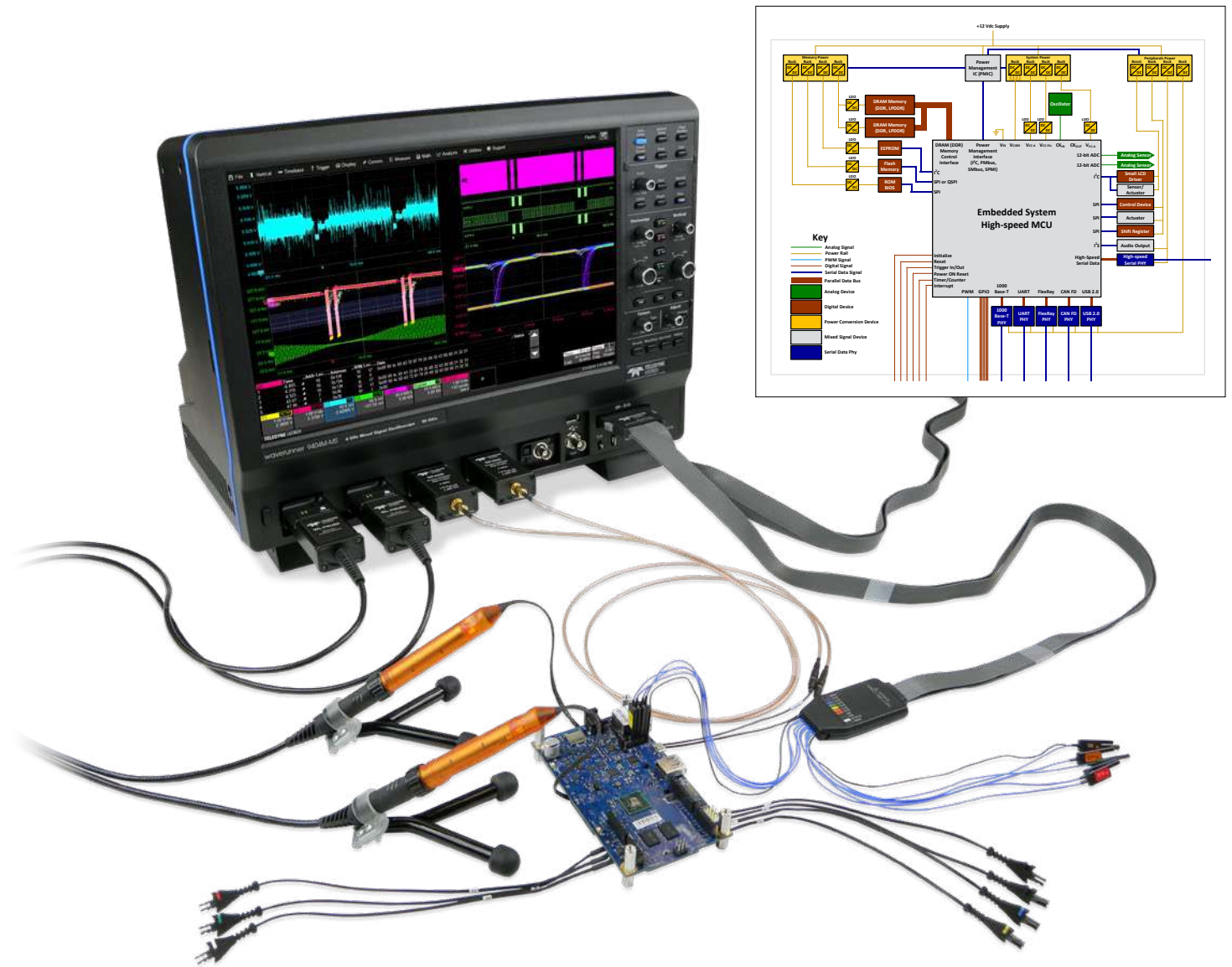

WaveRunner 9000 oscilloscopes have unsurpassed test, debug and validation tools to enable the most comprehensive embedded computing system (analog, digital and serial data) testing.

Powerful, deep toolbox

More standard math, measure, pass/fail and other toolsets provide faster and more complete insight into circuit problems. Many additional application packages are optionally available to enhance understanding.

Superior serial data toolsets

Comprehensive low-speed serial data triggers and decoders, plus measure/graph and eye diagram testing, provide the best causal analysis. Powerful serial data jitter analysis toolsets and compliance packages simplify complex validation.

Comprehensive probe offering

A wide selection of low voltage, high voltage and current probes accurately measures every signal in your circuit. In addition, probe adapters provide a simple and easy interface of third-party probes.



WaveRunner 9000 oscilloscopes provide a wide-range of validation and debug software which has been tailored to the specific test needs of the automotive industry.

Vehicle bus debug tools

Unique capabilities that build on triggering and decoding provide the most complete serial data debug and validation of automotive buses such as CAN, CAN FD, LIN, FlexRay, SENT, MOST, and more.

Ethernet beyond compliance

Cover all aspects of physical layer testing needs with compliance testing for 100Base-T1 and 1000Base-T1, and go beyond compliance with the unique and dedicated Automotive Ethernet debug toolkit.

Precise EMI/EMC analysis

4 GHz bandwidth and 40 GS/s sample rate along with dedicated, fully integrated Spectrum Analyzer and EMI/EMC packages enable root causes to be found quickly and easily.

ELECTROMAGNETIC COMPATIBILITY (EMC/EMI)

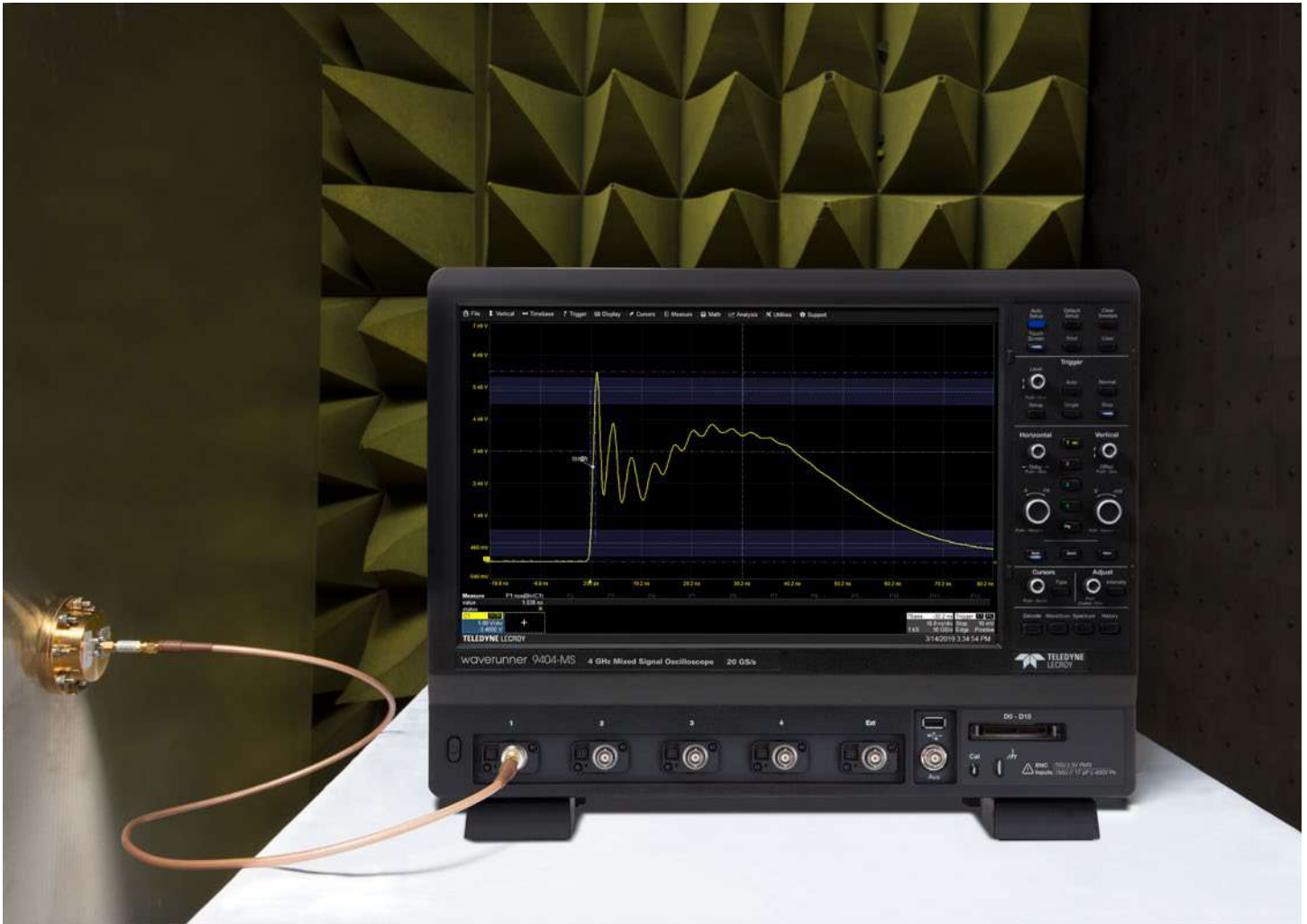

WaveRunner 9000 oscilloscopes accurately characterize EMC test signals with 40 GS/s, 1% gain accuracy, and a dedicated EMC pulse parameter package.

Pulse measurement fidelity

Fast pulse rise times require 2.5 to 4 GHz bandwidth at very high sample rates to ensure measurement confidence. WaveRunner 9000 provides the most accurate characterization using 40 GS/s sample rate and 1% gain accuracy.

Simplified frequency analysis

Spectrum Analyzer mode simplifies setup for analyzing EMI effects precisely. Identify instantaneous peak, quasi-peak, and maximum hold peaks across a wide EMI band using an interactive peaks and markers table. View the repetitive nature of harmonics with Spectrogram.

EMC pulse parameter package

Customizable measurements provide values per specific EMC/ESD standards. Level selections can be made to ignore undershoot, overshoot, or tail perturbations. Measurement filtering can limit measurement sets or ignore unwanted perturbations.

WAVERUNNER 9000 OSCILLOSCOPES AT A GLANCE



Key Attributes

1. 15.4" WXGA capacitive-touch screen display
2. MAUI with OneTouch optimized for convenience and efficiency
3. "Add New" button for fast waveform creation
4. "Push" Knobs – Provide shortcuts for common actions
5. Waveform Control Knobs – multiplexed for channel, zoom, math and memory traces
6. Cursor Knobs – Use cursors without opening a menu
7. Serial trigger captures signals up to 3 Gb/s
8. Dedicated buttons to quickly access popular debug tools.
9. Mixed Signal Capability with 16 digital channels
10. Four USB 3.1 Gen 1 ports
11. Reference Clock Input/Output connectors
12. USBTMC over USB 3.1

Enhanced Resolution using Filtering

WaveRunner 9000 oscilloscopes have standard capability to provide improved resolution (with bandwidth tradeoffs) by filtering. Each channel can be filtered independently. The filter result shows the number of effective bits improvement at a given bandwidth. Filtering is a good approach to higher resolution provided the tradeoffs between resolution and bandwidth are acceptable.

For more details, reference the section on filtering in the white paper:

[Comparing High Resolution Oscilloscope Design Approaches](#)

Noise Filter (ERes)
+2 bits
-3dB @ 580.0 MHz

WAVERUNNER 8000-R LOW-PROFILE OSCILLOSCOPE

Key Features

Low-profile design - <2U (3.5")

1, 2.5, and 4 GHz bandwidths

Up to 40 GS/s sample rate

Deep Memory - up to 128 Mpts

Fully software-compatible with the WaveRunner 9000

Remote connectivity via LXI, USBTMC, and LAN

Rackmount kit and removable SSD standard

Same powerful, deep toolbox of WaveRunner 9000 oscilloscopes

Support for ProBus active probes



WaveRunner 8000-R oscilloscopes utilize the WaveRunner 9000 acquisition system to provide a high-performance, 4 GHz oscilloscope in a convenient, low-profile form factor.

Low-Profile Form Factor

The WaveRunner 8000-R models provide a convenient form factor for a 4 GHz oscilloscope. The compact design has a height of less than 2U (3.5", 8.89 cm) and includes a standard rackmount kit, easily lending itself to be installed in an automated test environment.

Powerful, Deep Toolbox

Unlike most digitizing systems the WaveRunner 8000-R provides the powerful, deep toolbox that is expected in a Teledyne LeCroy oscilloscope. The full range of the WaveRunner 9000's analysis capability is available; including an array of serial protocol analysis packages and application specific packages.

Easily Transition Test Programs

The WaveRunner 8000-R models are fully software-compatible with their WaveRunner 9000 counterparts. Development can be conducted with the assistance of the front panel and display of the WaveRunner 9000 and then seamlessly transitioned to automated testing.

Flexible Connectivity Options

A variety of remote connectivity options (LXI, USBTMC, and LAN) offer flexibility when connecting to the WaveRunner 8000-R. Teledyne LeCroy's free WaveStudio software is a fast and easy way to analyze acquired waveforms off-line, or remotely control an oscilloscope from your desktop.

PROBES

Teledyne LeCroy offers an extensive range of probes to meet virtually every probing need.

Differential Probes (4 GHz)

Various
(see ordering information)



General purpose high-bandwidth probes with high dynamic range and offset. Wide variety of tips and leads available, including solder-in, QuickLink solder-in, HiTemp solder-in, quick connect tip, browser tip, square-pin.

ZS Series High Impedance Active Probes

ZS1000
ZS1500
ZS2500
ZS4000



High input impedance (1 MΩ), low 0.9 pF input capacitance and an extensive set of probe tips and ground accessories make these low-cost, single-ended probes ideal for a wide range of applications. The ZS Series is available up to 4 GHz bandwidth.

Differential Probes (200 MHz – 1.5 GHz)

ZD200, ZD500,
ZD1000, ZD1500
AP033



High bandwidth, excellent common-mode rejection ratio (CMRR) and low noise make these active differential probes ideal for applications such as automotive electronics and data communications. AP033 provides 10x gain for high-sensitivity measurement of series/shunt resistor voltages.

Active Voltage/Power Rail Probe

RP4030



Specifically designed to probe a low impedance power/voltage rail. The RP4030 has 30 V built-in offset adjust, low attenuation (noise), and high DC input impedance with 4 GHz of bandwidth. Featuring a wide assortment of tips and leads, including solder-in and U.FL receptacle connections.

High Voltage Fiber Optically-isolated Probe

HVFO103



The HVFO103 is a compact, simple, affordable probe for measurement of small signals (gate-drives, sensors, etc.) floating on an HV bus in power electronics designs, or for EMC, EFT, ESD and RF immunity testing sensor monitoring. Suitable for up to 35kV common-mode. 140 dB CMRR.

HVD Series High Voltage Differential Probes

HVD3102A, HVD3106A (1 kV)
HVD3206A (2 kV)
HVD3605A (6 kV)



Available with 1, 2 or 6 kV common-mode ratings. Excellent CMRR (65 dB @ 1 MHz) at high frequencies is combined with low inherent noise, wide differential voltage range, high offset voltage capabilities, and 1% gain accuracy. The ideal probe for power conversion system test.

High Voltage Passive Probes

HVP120, PPE4KV,
PPE5KV, PPE6KV



The HVP and PPE Series includes four fixed-attenuation probes covering a range from 1 kV to 6 kV. These probes are ideal for lightning/surge or EFT testing, or for probing in-circuit beyond the range of a LV-rate passive probe.

Current Probes

CP030, CP030A
CP031, CP031A,
CP150, CP500,
DCS025



Available in bandwidths up to 100 MHz with peak currents of 700 A and sensitivities to 1 mA/div. Extra-long cables (3 or 6 meters) available on some models. Ideal for component or power conversion system input/output measurements. DCS025 deskew calibration source also available.

Probe and Current Sensor Adapters

TPA10, CA10



TPA10 adapts supported Tektronix TekProbe-compatible probes to Teledyne LeCroy ProBus interface. CA10 is a programmable adapter for third-party current sensors that have voltage or current outputs proportional to measured current.

SPECIFICATIONS

	WaveRunner 9054	WaveRunner 9104/ 8104-R	WaveRunner 9254/ 9254M/8254M-R	WaveRunner 9404/ 9404M/8404M-R		
Vertical - Analog Channels						
Analog Bandwidth @ 50 Ω (-3 dB)	500 MHz (≥ 2 mV/div)	1 GHz (≥ 2 mV/div)	2.5 GHz (≥ 5 mV/div)	4 GHz (≥ 5 mV/div)		
Analog Bandwidth @ 1 MΩ (-3 dB)	500 MHz (typical)	500 MHz (typical)	500 MHz (typical)	500 MHz (typical)		
Rise Time (10–90%, 50 Ω – test limit)	700 ps (typical)	415 ps (typical)	160 ps (typical)	100 ps (typical)		
Rise Time (20–80%, 50 Ω – typical)	480 ps (typical)	290 ps (typical)	120 ps (typical)	75 ps (typical)		
Input Channels	4					
Vertical Resolution	8-bits; up to 11-bits with enhanced resolution (ERES)					
Effective Number of Bits (ENOB)	7.1 bits	6.9 bits	6.7 bits	6.4 bits		
Vertical Noise Floor (rms, 50 Ω)			WR 9254	WR 9254M/ 8254M-R	WR 9404	WR 9404M/ 8404M-R
1 mV/div	122 μV	165 μV	165 μV	165 μV	165 μV	165 μV
2 mV/div	122 μV	165 μV	165 μV	165 μV	165 μV	165 μV
5 mV/div	135 μV	177 μV	277 μV	274 μV	393 μV	368 μV
10 mV/div	190 μV	247 μV	346 μV	315 μV	476 μV	420 μV
20 mV/div	315 μV	406 μV	589 μV	504 μV	771 μV	657 μV
50 mV/div	0.74 mV	0.95 mV	1.25 mV	0.97 mV	1.48 mV	1.21 mV
100 mV/div	1.44 mV	1.83 mV	2.38 mV	1.79 mV	2.74 mV	2.25 mV
200 mV/div	3.15 mV	4.18 mV	6.01 mV	5.18 mV	7.38 mV	6.35 mV
500 mV/div	7.41 mV	9.58 mV	12.43 mV	9.81 mV	14.01 mV	11.57 mV
1 V/div	14.38 mV	18.52 mV	24.31 mV	18.52 mV	26.85 mV	21.74 mV
Sensitivity	50 Ω: 1 mV/div–1 V/div, fully variable; 1 MΩ: 1 mV/div–10 V/div, fully variable					
DC Vertical Gain Accuracy (Gain Component of DC Accuracy)	±1% F.S. (typical), offset at 0 V					
Channel-Channel Isolation	> 100:1 up to rated BW (typical)		DC -2.5 GHz: >100:1; 2.5 GHz to rated BW: >30:1 (typical)			
Offset Range	50 Ω: ±1.6 V @ 1 mV–4.95 mV/div, ±4 V @ 5 mV–9.9 mV/div, ±8 V @ 10 mV–19.8 mV/div, ±10 V @ 20 mV–1 V/div 1 MΩ: ±1.6 V @ 1 mV–4.95 mV/div, ±4 V @ 5 mV–9.9 mV/div, ±8 V @ 10 mV–19.8 mV/div, ±16 V @ 20 mV–100 mV/div, ±80 V @ 102 mV–1.0 V/div, ±160 V @ 1.02 V–10 V/div		50 Ω: BWL ≤ 1 GHz ±1.6 V @ 1 mV–4.95 mV/div, ±4 V @ 5 mV–9.9 mV/div, ±8 V @ 10 mV–19.8 mV/div, ±10 V @ 20 mV–1 V/div BWL > 1 GHz ±1.4 V @ 5 mV–100 mV/div, ±10 V @ 102 mV–1 V/div 1 MΩ: ±1.6 V @ 1 mV–4.95 mV/div, ±4 V @ 5 mV–9.9 mV/div, ±8 V @ 10 mV–19.8 mV/div, ±16 V @ 20 mV–140 mV/div, ±80 V @ 142 mV–1.4 V/div, ±160 V @ 1.42 V–10 V/div			
DC Vertical Offset Accuracy	±(1.5% of offset setting +1% of full scale + 1 mV) (test limit)					
Maximum Input Voltage	50 Ω: 5 V _{rms} ±10 V peak; 1 MΩ: 400 V max. (DC + peak AC < 10 kHz)					
Input Coupling	1 MΩ: AC, DC, GND; 50 Ω: DC, GND					
Input Impedance	50 Ω ±2% or 1 MΩ 17pF, 10 MΩ 9.5 pF with supplied Probe					
Bandwidth Limiters	20 MHz, 200 MHz	20 MHz, 200 MHz	20 MHz, 200 MHz, 1 GHz	20 MHz, 200 MHz, 1 GHz		
Rescaling	Length: meters, inches, feet, yards, miles; Mass: grams, slugs; Temperature: Celsius, Fahrenheit, Kelvin; Angle: radian, arcdeg, arcmin, arcsec, cycles, revolutions, turns; Velocity: m/s, in/s, ft/s, yd/s, miles/s; Acceleration: m/s ² , in/s ² , ft/s ² , g ₀ ; Volume: liters, cubic meters, cubic inches, cubic feet, cubic yards; Force (Weight): Newton, grain, ounce, pound; Pressure: Pascal, bar, atmosphere (technical), atmosphere (standard), torr, psi; Electrical: Volts, Amps, Watts, Volt-Amperes, Volt-Amperes reactive, Farad, Coulomb, Ohm, Siemen, Volt/meter, Coulomb/m ² , Farad/meter, Siemen/meter, power factor; Magnetic: Weber, Tesla, Henry, Amp/meter, Henry/meter; Energy: Joule, BTU, calorie; Rotating Machine: radian/second, frequency, revolution/second, revolution/minute, N·m, lb-ft, lb-in, oz-in, Watt, horsepower; Other: %					
Horizontal - Analog Channels						
Timebases	Internal timebase common to 4 input channels; an external clock may be applied at the EXT input					
Time/Division Range	20 ps/div - 1.6 ks/div with standard memory M Models: 20 ps/div - 6.4 ks/div with standard memory RIS available at ≤ 10 ns/div; Roll Mode available at ≥ 100 ms/div and ≤ 5 MS/s					
Clock Accuracy	≤ 1.5 ppm +(aging of 0.5 ppm/yr from last calibration)					
Sample Clock Jitter	Up to 10 μs Acquired Time Range: 100 fsrms (Internal Timebase Reference) Up to 10 ms Acquired Time Range: 360 fsrms (Internal Timebase Reference)					
Delta Time Measurement Accuracy	$\sqrt{2} * \sqrt{\left(\frac{\text{Noise}}{\text{SlewRate}}\right)^2 + (\text{Sample Clock Jitter})^2 \text{ (RMS)} + (\text{clock accuracy} * \text{reading}) \text{ (seconds)}}$					
Jitter Measurement Floor	$\sqrt{\left(\frac{\text{Noise}}{\text{SlewRate}}\right)^2 + (\text{Sample Clock Jitter})^2 \text{ (RMS, seconds, TIE)}}$					

SPECIFICATIONS

WaveRunner 9054

WaveRunner 9104/ 8104-R

WaveRunner 9254/ 9254M/8254M-R

WaveRunner 9404/ 9404M/8404M-R

Horizontal - Analog Channels (cont'd)

Channel-Channel Deskew Range	±9 x time/div. setting, each channel
External Timebase Reference (Input)	10 MHz ±25 ppm
External Timebase Reference (Output)	10 MHz 3.5 dBm ±1 dBm, synchronized to reference being used by user (internal or external reference)

Acquisition - Analog Channels

Sample Rate (Single-Shot)	10 GS/s on 4 Ch; 20 GS/s on 2 Ch	10 GS/s on 4 Ch; 20 GS/s on 2 Ch M Models: 20 GS/s on 4 Ch; 40 GS/s on 2 Ch
Memory Length Options (4 Ch / 2 Ch) (Number of segments in sequence acquisition mode)	16M / 32M / 32M (5,000)	16M / 32M / 32M (5,000) M Models: 64M / 128M / 128M (15,000)
Intersegment time	1 µs	
Averaging	Summed averaging to 1 million sweeps; continuous averaging to 1 million sweeps	
Interpolation	Linear or Sin x/x (2 pt and 5 pt)	

Vertical, Horizontal, Acquisition - Digital Channels (-MS Models only)

Maximum Input Frequency	250 MHz	
Minimum Detectable Pulse Width	2 ns	
Input Dynamic Range	± 20V	
Input Impedance (Flying Leads)	100 kΩ 5 pF	
Input Channels	16 Digital Channels	
Maximum Input Voltage	±30V Peak	
Minimum Input Voltage Swing	400 mV	
Threshold Groupings	Pod 2: D15 - D8, Pod 1: D7 - D0	
Threshold Selections	TTL, ECL, CMOS (2.5 V, 3.3 V, 5 V), PECL, LVDS or User Defined	
Threshold Accuracy	±(3% of threshold setting + 100mV)	
User Defined Threshold Range	±10 V in 20 mV steps	
User Defined Hysteresis Range	100 mV to 1.4 V in 100 mV steps	
Sample Rate	1.25 GS/s	
Record Length	32MS - 16 Channels	32MS - 16 Channels M Models: 128MS - 16 Channels
Channel-to-Channel Skew	350 ps	

Triggering System

Modes	Normal, Auto, Single, and Stop			
Sources	Any input channel, Ext, Ext/10, or line; slope and level unique to each source (except line trigger)			
Coupling	DC, AC, HFRej, LFRej			
Pre-trigger Delay	0 - 100% of memory size (adjustable in 1% increments or 100 ns)			
Post-trigger Delay	0 - 10,000 divisions in real time mode, limited at slower time/div settings or in roll mode			
Hold-off	From 2 ns up to 20 s or from 1 to 99,999,999 events			
Trigger and Interpolator Jitter	≤ 4 ps RMS (typical), < 0.1 ps RMS (typical, software assisted)			
Internal Trigger Level Range	±4.1 div from center (typical)			
External Trigger Level Range	Ext (±0.4 V); Ext/10 (±4 V)			
Maximum Trigger Rate	1,000,000 waveforms/second			
Trigger Sensitivity with Edge Trigger (Ch 1-4)	2 div @ < 500 MHz 1.5 div @ < 250 MHz 1 div @ < 200 MHz 0.9 div @ < 10 MHz (DC, AC, and LFRej coupling)	2 div @ < 1 GHz 1.5 div @ < 500 MHz 1 div @ < 200 MHz 0.9 div @ < 10 MHz (DC, AC, and LFRej coupling)	2 div @ < 2.5 GHz 1.5 div @ < 1.25 GHz 1 div @ < 200 MHz 0.9 div @ < 10 MHz (DC, AC, and LFRej coupling)	2 div @ < 4 GHz 1.5 div @ < 2 GHz 1 div @ < 200 MHz 0.9 div @ < 10 MHz (DC, AC, and LFRej coupling)
External Trigger Sensitivity, (Edge Trigger)	2 div @ 1 GHz 1.5 div @ < 500 MHz 1 div @ < 200 MHz 0.9 div @ < 10 MHz (DC, AC, and LFRej coupling)			
Max. Trigger Frequency, SMART Trigger	500 MHz @ ≥ 10 mV/div 1.2 ns (minimum triggerable width 1.2 ns)	1.0 GHz @ ≥ 10 mV/div (minimum triggerable width 750 ps)	2.0 GHz @ ≥ 10 mV/div (minimum triggerable width 300 ps)	2.0 GHz @ ≥ 10 mV/div (minimum triggerable width 200 ps)

SPECIFICATIONS

	WaveRunner 9054	WaveRunner 9104/ 8104-R	WaveRunner 9254/ 9254M/8254M-R	WaveRunner 9404/ 9404M/8404M-R
Trigger Types				
Edge	Triggers when signal meets slope (positive, negative, or either) and level condition.			
Width	Triggers on positive or negative glitches with widths selectable as low as 500 ps (depending on oscilloscope bandwidth) to 20 s, or on intermittent faults			
Glitch	Triggers on positive or negative glitches with widths selectable as low as 200 ps (depending on oscilloscope bandwidth) to 20 s, or on intermittent faults			
Window	Triggers when signal exits a window defined by adjustable thresholds			
Pattern	Logic combination (AND, NAND, OR, NOR) of 5 inputs (4 channels and external trigger input. Each source can be high, low, or don't care. The High and Low level can be selected independently. Triggers at start or end of the pattern			
TV-Composite Video	Triggers NTSC or PAL with selectable line and field; HDTV (720p, 1080i, 1080p) with selectable frame rate (50 or 60 Hz) and Line; or CUSTOM with selectable Fields (1–8), Lines (up to 2000), Frame Rates (25, 30, 50, or 60 Hz), Interlacing (1:1, 2:1, 4:1, 8:1), or Synch Pulse Slope (Positive or Negative)			
Runt	Trigger on positive or negative runts defined by two voltage limits and two time limits. Select between 1 ns and 20 ns			
Slew Rate	Trigger on edge rates. Select limits for dV, dt, and slope. Select edge limits between 1 ns and 20 ns			
Interval	Triggers on intervals selectable between 1 ns and 20 s			
Dropout	Triggers if signal drops out for longer than selected time between 1 ns and 20 s			
Exclusion Triggering	Trigger on intermittent faults by specifying the expected behavior and triggering when that condition is not met			
Measurement Trigger	Select from a large number of measurement parameters trigger on a measurement value with qualified limits.			
Multi-stage: Qualified	Triggers on any input source only if a defined state or edge occurred on another input source. Delay between sources is selectable by time or events.			
Multi-stage: Qualified First	In Sequence acquisition mode, triggers repeatably on event B only if a defined pattern, state, or edge (event A) is satisfied in the first segment of the acquisition. Holdoff between sources is selectable by time or events.			
Low Speed Serial Protocol Triggering (Optional)				
	I2C, SPI (SPI, SSPI, SIOP), UART-RS232, CAN1.1, CAN2.0, CAN FD, LIN, FlexRay, MIL-STD-1553			
Measurement Tools				
Measurement Functionality	Display up to 8 measurement parameters together with statistics including mean, minimum, maximum, standard deviation, and total number. Each occurrence of each parameter is measured and added to the statistics table. Histograms provide a fast, dynamic view of parameters and waveshape characteristics. Parameter math allows addition, subtraction, multiplication, or division of two different parameters. Parameter gates define the location for measurement on the source waveform. Parameter accept criteria define allowable values based on range setting or waveform state.			
Measurement Parameters - Horizontal + Jitter	Cycles (number of), Delay (from trigger, 50%), Δ Delay (50%), Duty Cycle (50%, @level), Edges (number of, @level), Fall Time (90-10, @levels), Frequency (50%, @level), Half Period (@level), Hold Time (@level), N Cycle Jitter (peak-peak), Number of Points, Period (50%, @level), Δ Period (@level), Phase (@level), Rise Time (10-90, @levels), Setup (@levels), Skew (@levels), Slew Rate (@levels), Time Interval Error (@level), Time (@level), Δ Time (@level), Width (50%, @level), Δ Width (@level), X(value)@max, X(value)@min			
Measurement Parameters - Vertical	Amplitude, Base, Level@X, Maximum, Mean, Median, Minimum, Peak-to-Peak, RMS, Std. Deviation, Top			
Measurement Parameters - Pulse	Area, Base, Fall Time (90-10, 80-20, @levels), Overshoot (positive, negative), Rise Time (10-90, 80-20, @levels), Top, Width (50%)			
Measurement Parameters - Statistical (on Histograms)	Full Width (@ Half Max, @%), Amplitude, Base, Peak@MaxPopulation, Maximum, Mean, Median, Minimum, Mode, Range, RMS, Std. Deviation, Top, X(value)@Peak, Peaks (number of), Percentile, Population (@bin, total)			
Math Tools				
Math Functionality	Display up to 8 math function traces (F1–F8). The easy-to-use graphical interface simplifies setup of up to two operations on each function trace, and function traces can be chained together to perform math-on-math.			
Math Operators - Basic Math	Average (summed), Average (continuous), Difference (–), Envelope, Floor, Invert (negate), Product (x), Ratio (/), Roof, Sum (+)			
Math Operators - Digital (incl. with MSO models/options)	Digital AND, Digital DFlipFlop, Digital NAND, Digital NOR, Digital NOT, Digital OR, Digital XOR			
Math Operators - Filters	Enhanced resolution (to 11 bits vertical), Interpolate (linear, cubic, sinx/x)			
Math Operators - Frequency Analysis	FFT (power spectrum, magnitude, phase, power density, real, imaginary, magnitude squared) up to full analysis memory length. Select from Rectangular, VonHann, Hamming, FlatTop and Blackman Harris windows.			
Math Operators - Functions	Absolute value, Correlation (two waveforms), Derivative, Deskew (resample), Exp (base e), Exp (base 10), Integral, Invert (negate), Log (base e), Log (base 10), Reciprocal, Rescale (with units), Square, Square root, Zoom (identity)			
Math Operators - Other	Segment, Sparse			
Measurement and Math Integration				
	Histograms to display statistical distributions of up to 2 billion measurement parameters. Trend (datalog) of up to 1 million measurement parameters. Track (display parameter vs. time, time-correlated to acquisitions) any parameter. Persistence histogram and persistence trace (mean, range, sigma)			
Pass/Fail Testing				
	Simultaneously test multiple parameters against selectable parameter limits or pre-defined masks. Pass or fail conditions can initiate actions including document to local or networked files, e-mail the image of the failure, save waveforms, send a pulse out at the front panel auxiliary BNC output, or (with the GPIB option) send a GPIB SRQ.			

SPECIFICATIONS

WaveRunner 9054

WaveRunner 9104/ 8104-R

WaveRunner 9254/ 9254M/8254M-R

WaveRunner 9404/ 9404M/8404M-R

Display System

Size	Color 15.4" widescreen capacitive touch screen
Resolution	WXGA; 1280 x 800 pixels
Number of Traces	Display a maximum of 16 traces. Simultaneously display channel, zoom, memory and math traces
Grid Styles	Auto, Single, Dual, Quad, Octal, X-Y, Single+X-Y, Dual+X-Y, Tandem, Quatro, Twelve, Sixteen
Waveform Representation	Sample dots joined, or sample dots only

Processor/CPU

Type	Intel® i5-6500 Quad Core, 3.2 GHz (or better), R Models: Intel® Celeron, 1.4 GHz (or better)
Processor Memory	8 GB standard, up to 16 GB optional M Models: 16 GB standard, R Models: 8 GB maximum
Operating System	Microsoft Windows® 10; R Models: Microsoft Windows® 7 Professional Edition (64-bit)
Real Time Clock	Date and time displayed with waveform in hardcopy files. SNTP support to synchronize to precision internal clocks

Connectivity

Ethernet Port	Supports 10/100/1000Base-T Ethernet interface (RJ45 port), R Models: includes 2 ports
USB Host Ports	4 side USB 3.1 Gen1 ports and 1 front USB 2.0 port support Windows compatible devices R Models: 2 rear USB 3.1 Gen1 ports, 2 rear USB 2.0 ports and 1 front 1 USB 2.0 port
USB Device Port	1 port - USBTMC over USB 3.1 Gen1, R Models: USBTMC over USB 2.0
GPIO Port (Optional)	Supports IEEE-488.2 (External)
External Monitor Port	1 HDMI 1.4 and 1 DisplayPort 1.2 Port. Includes support for extended desktop operation with UHD 3840 x 2160 pixel resolution on second monitor. R Models: 1 full-size Display Port connectors and 1 VGA.
Remote Control	Via Windows Automation, or via Teledyne LeCroy Remote Command Set
Network Communication Standard	VXI-11 or VICP, LXI Class C (v1.2) Compliant

Power Requirements

Voltage	100–240 VAC ±10% at 50/60 Hz ±5%; 100–120 VAC ±10% at 400 Hz ±5%; Automatic AC Voltage Selection
Nominal Power Consumption	285 W / 285 VA, M Models: 415 W / 415 VA, R Models: 240 W / 240 VA, M-R Models: 340 W / 340 VA
Max Power Consumption	375 W / 375 VA, M Models: 500 W / 500 VA, R Models: 320 W / 320 VA, M-R Models: 420 W / 420 VA with all PC peripherals, active probes connected to 4 channels, and MSO active

Environmental

Temperature (Operating)	+5 °C to +40 °C
Temperature (Non-Operating)	–20 °C to +60 °C
Humidity (Operating)	5% to 90% relative humidity (non-condensing) up to +31 °C Upper limit derates to 50% relative humidity (Non-condensing) at +40 °C
Humidity (Non-Operating)	5% to 95% relative humidity (non-condensing) as tested per MIL-PRF-28800F
Altitude (Operating)	Up to 3,000 m at or below +30 °C
Altitude (Non-Operating)	Up to 40,000 ft (12,192 m)
Random Vibration (Operating)	0.31 g _{rms} 5 Hz to 500 Hz, 15 minutes in each of three orthogonal axes
Random Vibration (Non-Operating)	2.4 g _{rms} 5 Hz to 500 Hz, 15 minutes in each of three orthogonal axes
Functional Shock	30 g _{peak} , half sine, 11 ms pulse, 3 shocks (positive and negative) in each of three orthogonal axes, 18 shocks total

Size and Weight

Dimensions (HWD)	14.1" H x 17.5" W x 9.5" D (358 x 445 x 242 mm)
Weight	25.8 lbs. (11.7 kg)

Certifications

CE Certification	CE Compliant, UL and cUL listed; Conforms to UL 61010-1 (3rd Edition), UL 61010-2-030 (1st Edition)
UL and cUL Listing	CAN/CSA C22.2 No. 61010-1-12, R Models: CE Compliant

Warranty and Service

3-year warranty; calibration recommended annually. Optional service programs include extended warranty, upgrades, and calibration services.

ORDERING INFORMATION

Product Description Product Code

WaveRunner 9000 Oscilloscopes

500 MHz, 20 GS/s, 4ch, 16 Mpts/Ch Oscilloscope with 15.4" WXGA widescreen capacitive touch screen. 32 Mpts/Ch in interleaved mode.	WaveRunner 9054
1 GHz, 20 GS/s, 4ch, 16 Mpts/Ch Oscilloscope with 15.4" WXGA widescreen capacitive touch screen. 32 Mpts/Ch in interleaved mode.	WaveRunner 9104
2.5 GHz, 20 GS/s, 4ch, 16 Mpts/Ch Oscilloscope with 15.4" WXGA widescreen capacitive touch screen. 32 Mpts/Ch in interleaved mode.	WaveRunner 9254
4 GHz, 20 GS/s, 4ch, 16 Mpts/Ch Oscilloscope with 15.4" WXGA widescreen capacitive touch screen. 32 Mpts/Ch in interleaved mode.	WaveRunner 9404
2.5 GHz, 40 GS/s, 4ch, 64 Mpts/Ch Oscilloscope with 15.4" WXGA widescreen capacitive touch screen. 128 Mpts/Ch in interleaved mode.	WaveRunner 9254M
4 GHz, 40 GS/s, 4ch, 64 Mpts/Ch Oscilloscope with 15.4" WXGA widescreen capacitive touch screen. 128 Mpts/Ch in interleaved mode.	WaveRunner 9404M
500 MHz, 20 GS/s, 4ch, 16 Mpts/Ch Mixed Signal Oscilloscope with 15.4" WXGA widescreen capacitive touch screen. 32 Mpts/Ch in interleaved mode.	WaveRunner 9054-MS
1 GHz, 20 GS/s, 4ch, 16 Mpts/Ch Mixed Signal Oscilloscope with 15.4" WXGA widescreen capacitive touch screen. 32 Mpts/Ch in interleaved mode.	WaveRunner 9104-MS
2.5 GHz, 20 GS/s, 4ch, 16 Mpts/Ch Mixed Signal Oscilloscope with 15.4" WXGA widescreen capacitive touch screen. 32 Mpts/Ch in interleaved mode.	WaveRunner 9254-MS
4 GHz, 20 GS/s, 4ch, 16 Mpts/Ch Mixed Signal Oscilloscope with 15.4" WXGA widescreen capacitive touch screen. 32 Mpts/Ch in interleaved mode.	WaveRunner 9404-MS
2.5 GHz, 40 GS/s, 4ch, 64 Mpts/Ch Mixed Signal Oscilloscope with 15.4" WXGA widescreen capacitive touch screen. 128 Mpts/Ch in interleaved mode.	WaveRunner 9254M-MS
4 GHz, 40 GS/s, 4ch, 64 Mpts/Ch Mixed Signal Oscilloscope with 15.4" WXGA widescreen capacitive touch screen. 128 Mpts/Ch in interleaved mode.	WaveRunner 9404M-MS

Included with Standard Configurations (WaveRunner 9000 and WaveRunner 9000-MS)

±10, 500 MHz Passive Probe (Qty. 4), Protective Cover, Getting Started Guide, Anti-virus Software (Trial Version), Microsoft Windows® 10, Commercial NIST Traceable Calibration with Certificate, Power Cable for the Destination Country, 3-year Warranty

Included with WaveRunner 9000-MS

16-Channel Digital Leadset, Extra Large Gripper Probe Set (Qty. 22), Ground Extenders (Qty. 20), Flexible Ground Leads (Qty. 5)

Computer Upgrade

256 GB Removable Solid State Drive Option	WR9K-256GB-RSSD
Additional 256 GB Solid State Drive for use with RSSD option. Includes Windows 10, LeCroy Oscilloscope Software and Critical Scope Operational File Duplicates.	WR9K-256GB-RSD-02
Upgrade from 8 GB RAM to 16 GB RAM	WR9K-UPG-16GBRAM

Product Description Product Code

WaveRunner 8000-R Oscilloscopes

1 GHz, 10 GS/s, 4ch, 16 Mpts/Ch, 2U form factor Oscilloscope. 20 GS/s, 32 Mpts/Ch in interleaved mode.	WaveRunner 8104-R
2.5 GHz, 20 GS/s, 4ch, 64 Mpts/Ch, 2U form factor Oscilloscope. 40 GS/s, 128 Mpts/Ch in interleaved mode.	WaveRunner 8254M-R
4 GHz, 20 GS/s, 4ch, 64 Mpts/Ch, 2U form factor Oscilloscope. 40 GS/s, 128 Mpts/Ch in interleaved mode.	WaveRunner 8404M-R

Serial Trigger and Decode

MIL-STD-1553 Trigger and Decode Option	WR9K-1553 TD
MIL-STD-1553 Trigger, Decode, Measure/Graph, and Eye Diagram Option	WR9K-1553 TDME
8b10b Decode Option - Includes 80 bit 3.125 Gb/s serial trigger	WR9K-80B-8b10b TD
ARINC 429 Bus Symbolic Decode, Measure/Graph, and Eye Diagram Option	WR9K-ARINC429BUS DME SYMBOLIC
ARINC 429 Bus Symbolic Decode Option	WR9K-ARINC429BUS DSYMBOLIC
AudioBus Trigger and Decode Option	WR9K-Audiobus TD
AudioBus trigger, decode, and graph Option	WR9K-Audiobus TDG
CAN FD Trigger and Decode Option	WR9K-CAN FDBUS TD
CAN FD Trigger, Decode, Measure/Graph, and Eye Diagram Option	WR9K-CAN FDBUS TDME
CAN FD Symbolic Trigger, Decode, and Measure/Graph, and Eye Diagram Option	WR9K-CAN FDBUS TDME SYMBOLIC
CAN Trigger & Decode Option	WR9K-CANBUS TD
CAN Trigger, Decode, Measure/Graph, and Eye Diagram Option	WR9K-CANBUS TDME
CAN Symbolic Trigger, Decode, and Measure/Graph, and Eye Diagram Option	WR9K-CANBUS TDME SYMBOLIC
DigRF 3G Bus Decode Option	WR9K-DigRF3Gbus D
DigRF V4 Bus Decode Option	WR9K-DigRFV4bus D
MIPI D-PHY CSI-2, DSI Bus Decode Option	WR9K-DPHYbus D
MIPI D-PHY CSI-2, DSI Bus Decode and Physical Layer Test Option	WR9K-DPHYbus DP
Bundle: includes I2C, SPI, UART-RS232 Trigger and Decode Option	WR9K-EMB TD
Bundle: includes I2C, SPI, UART-RS232 Trigger, Decode, Measure/Graph, and Eye Diagram Option	WR9K-EMB TDME
ENET Bus Decode Option	WR9K-ENETbus D
FibreChannel decode annotation Option	WR9K-FCbus D
FlexRay Trigger and Decode Option	WR9K-FLEXRAYBUS TD
FlexRay Trigger, Decode, Measure/Graph and Physical Layer Option	WR9K-FLEXRAYBUS TDMP
I2C Trigger and Decode Option	WR9K-I2CBUS TD
I2C Trigger, Decode, Measure/Graph, and Eye Diagram Option	WR9K-I2CBUS TDME
LIN Trigger and Decode Option	WR9K-LINBUS TD
LIN Trigger, Decode, Measure/Graph, and Eye Diagram Option	WR9K-LINBUS TDME
Manchester Bus Decode Option	WR9K-MANCHESTERbus D
MDIO Decode Option	WR9K-MDIOBUS D
MIPI M-PHY Bus Decode Option	WR9K-MPHYbus D
MIPI M-PHY Bus Decode and Physical Layer Test Option	WR9K-MPHYbus DP
NRZ Bus Decode Option	WR9K-NRZbus D
PCIe Gen 1 Decode Option	WR9K-PCIebus D
Serial Debug Toolkit - Measure Analyze Graph Option	WR9K-PROTOBUS MAG

ORDERING INFORMATION

Product Description Product Code

Serial Trigger and Decode (cont'd)

Decode Annotation and Protocol Analyzer Synchronization Option	WR9K-ProtoSync
Decode Annotation and Protocol Analyzer+Bit Tracer Synchronization Option	WR9K-ProtoSync-BT
SAS Decode annotation Option	WR9K-SASbus D
SATA Decode Option	WR9K-SATAbus D
SENT Bus Decode Option	WR9K-SENTbus D
SpaceWire Decode Option	WR9K-SPACEWIREbus D
SPI Trigger and Decode Option	WR9K-SPIBUS TD
SPI Trigger, Decode, Measure/Graph, and Eye Diagram Option	WR9K-SPIBUS TDME
SPMI Decode Option	WR9K-SPMIbus D
UART-RS232 Trigger and Decode Option	WR9K-UART-RS232BUS TD
UART-RS232 Trigger, Decode, Measure/Graph, and Eye Diagram Option	WR9K-UART-RS232BUS TDME
MIPI UniPro Protocol Decoder Software Option	WR9K-UNIPRObus D
MPHY to UniPro Decoder Software Upgrade	WR9K-UPG-MPHY-UNIPRObus D
MPHY REQUIRED	
USB 2.0 Trigger and Decode Option	WR9K-USB2BUS TD
USB 2.0 Trigger, Decode, Measure/Graph, and Eye Diagram Option	WR9K-USB2BUS TDME
USB 2.0 HSIC Decode Option	WR9K-USB2-HSICbus D

Serial Data Compliance

QualiPHY Enabled BroadR-Reach Software Option	QPHY-BroadR-Reach
QualiPHY Enabled DDR2 Software Option	QPHY-DDR2
QualiPHY Enabled DDR3 Software Option	QPHY-DDR3
QualiPHY Enabled 1000-BaseT1 Compliance Software Option	QPHY-1000BASE-T1
QualiPHY Enabled Ethernet 10/100/1000BT Software Option	QPHY-ENET*
QualiPHY Enabled LPDDR2 Software Option	QPHY-LPDDR2
QualiPHY Enabled MIPI D-PHY Software Option	QPHY-MIPI-DPHY
QualiPHY Enabled MOST150 Software Option	QPHY-MOST150
QualiPHY Enabled MOST50 Software Option	QPHY-MOST50
QualiPHY Enabled USB 2.0 Software Option	QPHY-USB‡
10/100/1000Base-T Ethernet Test Fixture	TF-ENET-B**
USB 2.0 Compliance Test Fixture	TF-USB-B

* TF-ENET-B required ‡ TF-USB-B required

** Includes ENET-2CAB-SMA018 and ENET-2ADA-BNCSMA

DDR Debug Toolkits

DDR2 and LPDDR2 Debug Toolkit	WR9K-DDR2-TOOLKIT
DDR3, DDR3L, LPDDR3, DDR2, and LPDDR2 Debug Toolkit	WR9K-DDR3-TOOLKIT
DDR3, DDR3L, LPDDR3, DDR2, and LPDDR2 Debug Toolkit Upgrade	WR9K-UPG-DDR3-TOOLKIT

Serial Data Analysis

Single-Lane Serial Data Analysis, Eye, Jitter and Noise Measurements for WaveRunner 9000	WR9K-SDAIII
Eye Doctor II - Channel & Fixture De-embedding/Emulation, Tx/Rx Equalization	WR9K-EYEDRII
Serial Data Mask Software Package	WR9K-SDM
Cable De-Embedding Option	WR9K-CBL-DE-EMBED

Product Description Product Code

Data Storage Software

Advanced Optical Recording Measurement Package	WR9K-AORM
Disk Drive Analyzer Software Package	WR9K-DDA
Disk Drive Measurements Software Package	WR9K-DDM2

Power Analysis Software

Power Analyzer Software Option	WR9K-PWR
--------------------------------	----------

Jitter Analysis Software

Clock, Clock-Data Jitter Analysis and Views of Time, Statistical, Spectral, and Jitter Overlay	WR9K-JITKIT
------------------------------------------------------------------------------------------------	-------------

Digital Filtering Software

Digital Filter Software Option	WR9K-DFP2
--------------------------------	-----------

Other Software Options

EMC Pulse Parameter Software	WR9K-EMC
Electrical Telecom Pulse Mask Test	WR9K-ET-PMT
Spectrum Analyzer and Advanced FFT	WR9K-SPECTRUM
VectorLinQ Vector Signal Analysis	WR9K-VECTORLINQ
Advanced Customization	WR9K-XDEV

Remote Control/Network Options

External USB2 to GPIB Adaptor	USB2-GPIB
-------------------------------	-----------

General Accessories

WaveRunner 9000 Rackmount Kit	WR9K-RACK
WaveRunner 9000 Carrying Case	WR9K-CARRYCASE

ORDERING INFORMATION

Product Description	Product Code
Probes	
Power/Voltage Rail Probe with 4 GHz bandwidth, 1.2x attenuation, ± 30 V offset, ± 800 mV	RP4030
High Voltage Fiber Optic Probe, 60 MHz bandwidth	HVF0103
500 MHz Passive Probe, 2.5mm, 10:1, 10 M Ω	PP022
500 MHz Passive Probe, 5mm, 10:1, 10 M Ω	PP024
1 GHz, 0.9 pF, 1 M Ω High Impedance Active Probe	ZS1000
Set of 4 ZS1000 Active Probes	ZS1000-QUADPAK
1.5 GHz, 0.9 pF, 1 M Ω High Impedance Active Probe	ZS1500
Set of 4 ZS1500 Active Probes	ZS1500-QUADPAK
2.5 GHz, 0.9 pF, 1 M Ω High Impedance Active Probe	ZS2500
Set of 4 ZS2500 Active Probes	ZS2500-QUADPAK
4 GHz, 0.6 pF, 1 M Ω High Impedance Active Probe	ZS4000
200 MHz, 3.5 pF, 1 M Ω Active Differential Probe, ± 20 V	ZD200
500 MHz, 1.0 pF Active Differential Probe, ± 8 V	ZD500
1 GHz, 1.0 pF Active Differential Probe, ± 8 V	ZD1000
1.5 GHz, 1.0 pF Active Differential Probe, ± 8 V	ZD1500
500 MHz, Active Differential Probe ($\div 1$, $\div 10$, $\div 100$)	AP033
4 GHz ProBus2 Differential Probe with Adjustable Tip	D400A-AT-PB2
4 GHz, 2.5 Vp-p ProBus2 Differential Probe	D410-A-PB2
4 GHz, 5 Vp-p ProBus2 Differential Probe	D420-A-PB2
WaveLink ProBus2 Platform/Cable Assembly	WL-PBUS2
30 A; 50 MHz Current Probe – AC/DC; 30 Arms; 50 A Peak Pulse	CP030
30 A, 10 MHz Current Probe - AC/DC, 30 Arms, 50 A Peak Pulse, 3-meter Cable	CP030-3M
30A, 50 MHz High Sensitivity Current Probe - AC/DC, 30 Arms, 50 A Peak Pulse, 1.5-meter Cable	CP030A
30 A; 100 MHz Current Probe – AC/DC; 30 Arms; 50 A Peak Pulse	CP031
30A, 100 MHz High Sensitivity Current Probe - AC/DC, 30 Arms, 50 A Peak Pulse, 1.5-meter Cable	CP031A
150 A; 10 MHz Current Probe – AC/DC; 150 Arms; 500 A Peak Pulse	CP150
150 A, 5 MHz Current Probe - AC/DC, 150 Arms, 500 A Peak Pulse, 6-meter Cable	CP150-6M
500 A; 2 MHz Current Probe – AC/DC; 500 Arms; 700 A Peak Pulse	CP500
Deskew Calibration Source	DCS025
Programmable Current Sensor to ProBus Adapter (for third-party current sensors)	CA10
100:1 400 MHz 50 M Ω 1 kV High-Voltage Probe	HVP120
100:1 400 MHz 50 M Ω 4 kV High-Voltage Probe	PPE4KV
1000:1 400 MHz 50 M Ω 5 kV High-Voltage Probe	PPE5KV
1000:1 400 MHz 5 M Ω / 50 M Ω 6 kV High-Voltage Probe	PPE6KV

Product Description	Product Code
Probes (cont'd)	
TekProbe to ProBus Probe Adapter	TPA10
Optical-to-Electrical Converter, 500-870 nm ProBus BNC Connector	OE425
Optical-to-Electrical Converter, 950-1630 nm ProBus BNC Connector	OE455
1 kV, 25 MHz High Voltage Differential Probe	HVD3102A
1 kV, 25 MHz High Voltage Differential Probe (without tip accessories)	HVD3102A-NOACC
1 kV, 120 MHz High Voltage Differential Probe	HVD3106A
1 kV, 120 MHz High Voltage Differential Probe (without tip accessories)	HVD3106A-NOACC
1 kV, 80 MHz High Voltage Differential Probe with 6-meter Cable and Auto Zero Disconnect	HVD3106A-6M
2 kV, 120 MHz High Voltage Differential Probe	HVD3206A
2 kV, 80 MHz High Voltage Differential Probe with 6-meter Cable	HVD3206A-6M
6 kV, 100 MHz High Voltage Differential Probe	HVD3605A



1-800-5-LeCroy
teledynelecroy.com

Local sales offices are located throughout the world.
Visit our website to find the most convenient location.

© 2019 by Teledyne LeCroy, Inc. All rights reserved. Specifications, prices, availability, and delivery subject to change without notice. Product or brand names are trademarks or requested trademarks of their respective holders.

PCI Express® is a registered trademark and/or service mark of PCI-SIG.

MATLAB® is a registered trademark of The MathWorks, Inc. All other product or brand names are trademarks or requested trademarks of their respective holders.

waverunner9000-ds-01apr19